



DE MARI

*Extrusion Dies & Equipment for the
Food Industry*





DE MARI

*Extrusion Dies & Equipment for the
Food Industry*

We Shape the World

DE MARI is a leading manufacturer in extrusion dies and equipment for the food industry. DE MARI's state of the art manufacturing facility is located 25 miles north of Boston, Massachusetts, and houses the latest Computer Numeric Controlled equipment and manufacturing software the world has to offer. Armed with more than 40 years of industry experience and modern day technologies, DE MARI has grown into one of the largest die manufactures in the world.

At DE MARI our mission is to provide exceptional products and unequivocal service to the food producing community.

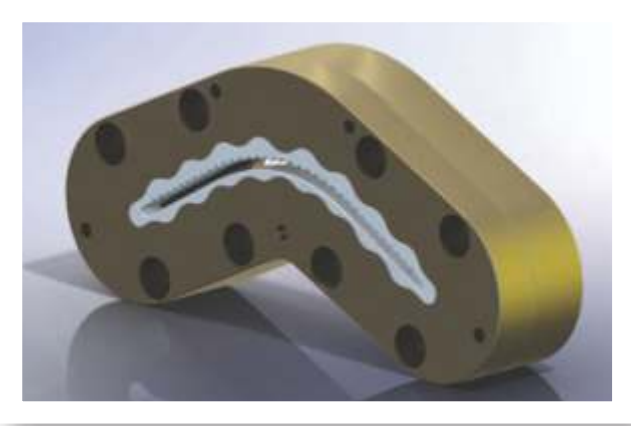

DE MARI es un líder en la fabricación de moldes de extrusión para la industria alimenticia. La modernísima planta de fabricación DE MARI está localizada a 25 millas norte de Boston, Massachusetts, donde se encuentran las más modernas maquinarias computarizadas de control numérico y con los últimos programas de fabricación que el mundo ofrece.

Contando con sus más de cuarenta años de experiencia en la industria y combinándolo con las tecnologías modernas, esto ha motivado el crecimiento de la DE MARI como uno de los líderes mundiales en la fabricación de moldes en el mundo.

Nuestra misión es de proveer productos excepcionales y un servicio único a la comunidad de productos alimenticios.

DE MARI é líder na fabricação de moldes de extrusão para a industria alimenticia, a modernissima empresa de fabricação De Mari esta localizada a 40 kilometros ao norte de Boston, Massachusetts onde se encontram os mais modernos equipamentos CNC e com os mais avançados programas de fabricação que o mundo oferece. A empresa conta com mais de quarenta anos de experiência na industria e combinando com as mais modernas tecnologias fez com que DE MARI crescesse e se tonasse em um dos maiores produtores de moldes no mundo.

Nossa missão é prover produtos excepcionais com um serviço unico a toda a comunidade de produtos alimenticios.

DE MARI e' leader nella produzione di trafilè per l'industria alimentare. La modernissima industria della DE MARI si trova a 25 miglia a nord di Boston, e' fornita delle piu' moderne Macchine a Controllo Numerico e programmi software, che il mercato mondiale offre.

Piu' di 40 anni d'esperienza nell'industria , insieme alle piu' moderne tecnologie, hanno contribuito alla crescita della DE MARI, diventando una delle piu' grandi industrie di trafilè nel mondo.



Alla DE MARI la nostra missione, e' quella di fornire prodotti e servizio unico, al settore alimentare.

Table of Contents

Long Goods	6 - 7
Short Goods	8 - 17
Pastina	18 - 19
Special Shapes	20 - 21
Quick Cooking	22
Brass Shapes	22 - 24
Figure Shapes	25 - 26

This catalog contains some examples, however, we can manufacture any shape to your exact specifications.

Estas dos páginas contienen unos ejemplos. Nosotros podemos producir cualquier tipo de forma para sus exactas especificaciones. Contáctenos para más información.











DE MARI

Extrusion Dies & Equipment for the Food Industry

Long Goods



-  2001 Spaghetti mm 2
-  2002 Spaghetti mm 1.9
-  2003 Spaghetti mm 1.8
-  2004 Spaghetti mm 1.7
-  2005 Spaghetti mm 1.6
-  2006 Spaghetti mm 1.4
-  2007 Spaghetti mm 1.2
-  2008 Spaghetti mm 1.1
-  2009 Spaghetti mm .09



2010 Ancorotto mm 1.95



2011 Trifoglio mm 1.7



- 2012 Linguine mm 1.8
- 2013 Linguine mm 2.7
- 2014 Linguine mm 2.8
- 2015 Linguine mm 3.1
- 2016 Linguine mm 4.8



- 2017 Fettuccine mm 4.5
- 2018 Fettuccine mm 4.8
- 2019 Fettuccine mm 5
- 2020 Fettuccine mm 5.5

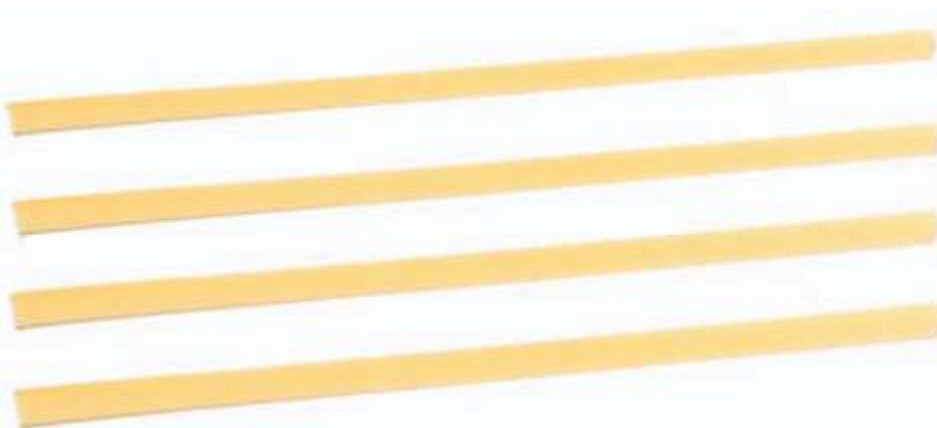



DE MARI

Extrusion Dies & Equipment for the Food Industry

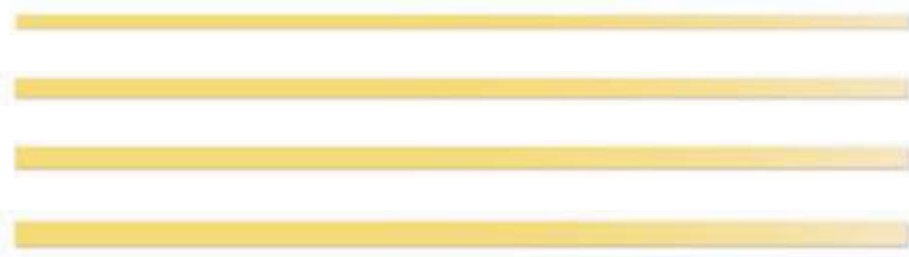

2021
Bucatini mm 2.5
2022
Bucatini mm 2.5
2023
Bucatini mm 2.5
2024
Bucatini mm 2.5



2.50



2030
Reginelle F.D. mm 12.5

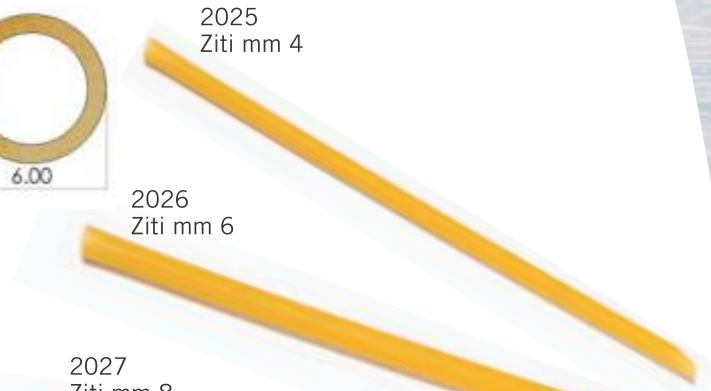

2025
Ziti mm 4

2026
Ziti mm 6

2027
Ziti mm 8



2032
Reginelle F.D. mm 22



2028
Ziti mm 9



2034
Lasagne F.D. Ondulate mm55



2033
Lasagne F.D. mm47

2134
Fusilli forati lunghi mm 3x1, 1





DE MARI

Extrusion Dies & Equipment for the
Food Industry

Short Goods



2037
Conchiglie mm 25 righi 18



2038
Conchiglie mm 17.5 righi 12



2039
Conchiglie mm 27 righi 20



2040
Conchiglie mm 11.5 righi 12

2042
Conchiglie mm 70 righi 34

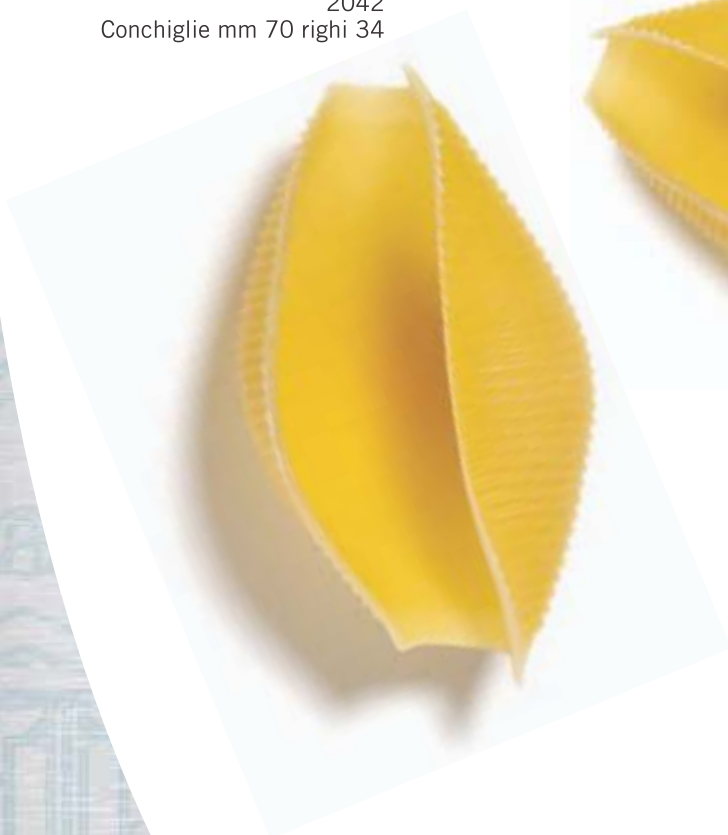

2041
Conchiglie mm 60 righi 35



2043
Conchiglie mm 65 righi 34



DE MARI

Extrusion Dies & Equipment for the
Food Industry

2044
Gnocchi mm 28



2046
Gnocchi mm 30



2047
Gnocchi sardi mm 16 righi 10



2050
Conchiglie mm 12



2051
Conchiglie mm 6



2052
Conchiglie mm 13



2053
Conchiglie mm 11



DE MARI

Extrusion Dies & Equipment for the
Food Industry

Short Goods



2061
Creste di gallo mm 8.5 righi 18



2058
Pipe mm 9 righi 18



2065
Cornetti mm 12 righi 24



2063
Cornetti mm 8 righi 12



2064
Cornetti mm 7 righi 16



2067
Cornetti mm 5



2066
Cornetti mm 4.5



2068
Cornetti mm 7



DE MARI

*Extrusion Dies & Equipment for the
Food Industry*

2070
Eliche mm 10



2069
Eliche mm 12



2072
Eliche mm 8



2075
Fusilli mm 10



2073
Fusilli mm 9.5



2074
Fusilli mm 13



DE MARI

Extrusion Dies & Equipment for the
Food Industry

Short Goods



2077
Penne mm 15



2078
Penne mm 10.5



2085
Penne mm 12 righi 26



2081
Penne mm 7.5



2083
Penne mm 8 righi 20



2084
Penne mm 8 righi 18



2086
Penne mm 6.5 righi 14



2087
Penne mm 5.2 righi 14



2093
Tubetti mm 8.5

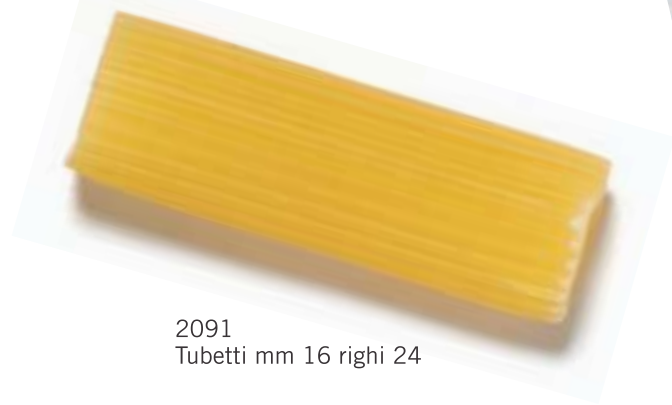

2091
Tubetti mm 16 righi 24



2094
Tubetti mm 7.5



2097
Tubetti mm 3.5



2098
Ditali mm 16 righi 24



2099
Ditali mm 14 righi 22



DE MARI

Extrusion Dies & Equipment for the
Food Industry

Short Goods



2101
Tubetti mm 15 righi 20



2100
Tubetti mm 16 righi 24



2102
Tubetti mm 14 righi 21



2103
Tubetti mm 11 righi 16



2104
Tubetti mm 12 righi 16



2107
Elicoidali mm 11.5 righi 12



2108
Elicoidali mm 10.5 righi 10





DE MARI

Extrusion Dies & Equipment for the
Food Industry



2109
Tagliolini corti mm 3



2111
Tagliatelle avvolte mm 6



2110
Tagliolini corti mm 1.6

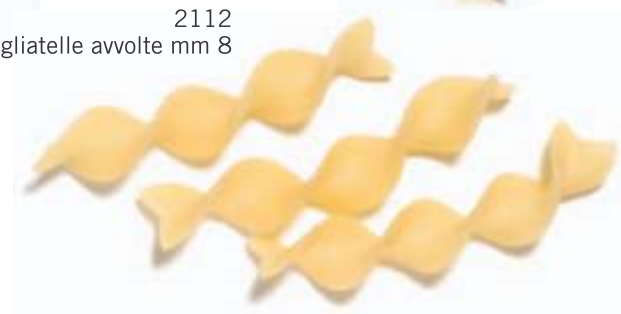

2112
Tagliatelle avvolte mm 8



2115
Reginelle ondulate doppie mm 13



2113
Tagliatelle avvolte mm 10

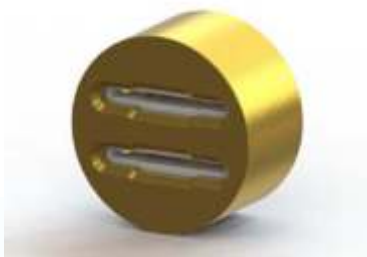

2114
Tagliatelle avvolte mm 15



2117
Reginelle ondulate doppie mm 20



2119
Pasta Mista



DE MARI

Extrusion Dies & Equipment for the
Food Industry

Short Goods



2121
Cavatappi mm 5.5
righti 8



2122
Cavatappi mm 5.5
righti 10



2123
Cavatappi mm 6
righti 10



2120
Cavatappi mm 4
righti 8



2125
Cavatappi mm 7
righti 10



2126
Radiatori mm 18



2124
Cavatappi mm 6.5
righti 10



2129
Gemelli mm 5.5



DE MARI

*Extrusion Dies & Equipment for the
Food Industry*



2130
Gemelli mm 6



2131
Gemelli mm 7



2144
Trottole mm 16



2138
Ruote mm 14 righi 36

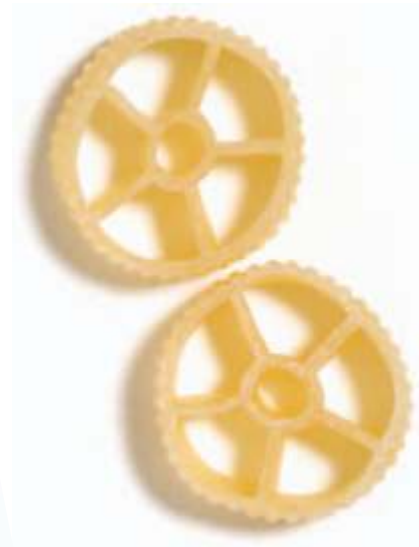

2137
Ruote mm 18 righi 44



2142
Festonate mm 18



DE MARI

Extrusion Dies & Equipment for the
Food Industry

Pastina



2147
Spaghetti corti mm 1.5



2150
Anellini mm 5



2149
Semi di melone mm 5.5



2152
Stelline mm 6



2153
Ditali mm 7.5



2154
Alfabeto mm 6.5



2155
Orzo mm 9.5



2157
Ditalini mm 5 righi 7



2156
Ditalini mm 3



2159
Ditalini mm 5.5 righi 12



DE MARI

Extrusion Dies & Equipment for the
Food Industry



2158
Anelli mm 12



2164
Stelline 6 punte mm 6



2167
Tubettini mm 3.5



2165
Grattini mm 3

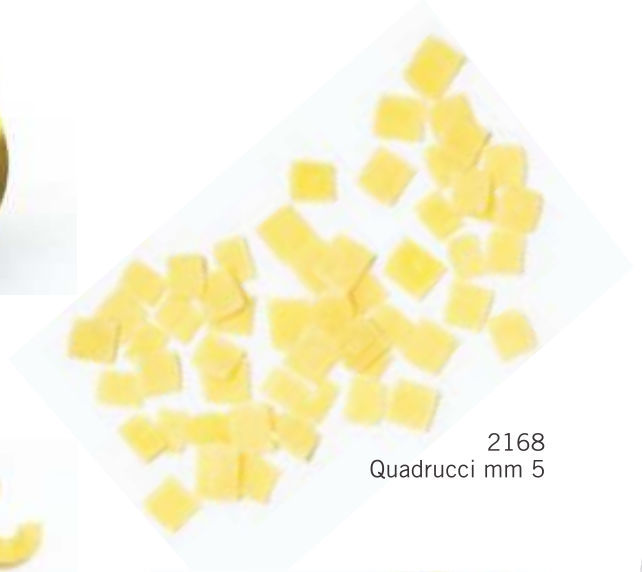

2168
Quadrucci mm 5

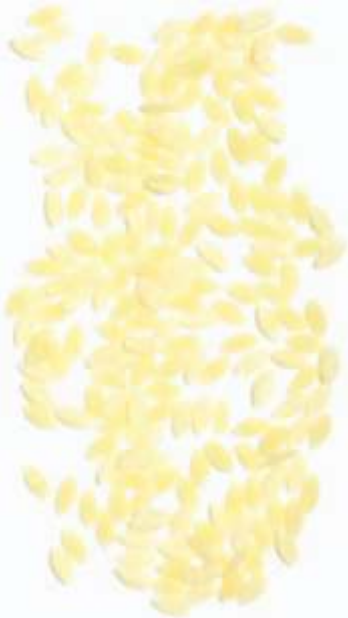

2169
Puntine



2170
Ricciutelli



2181
Semi Ovali



2182
Semi di Melone



2183
Puntine



DE MARI

Extrusion Dies & Equipment for the
Food Industry

Special Shapes



2171
Tagliatelle nido mm 7.5



2173
Tagliolini nido mm 1.75



2172
Tagliatelle nido mm 8.5



2174
Tagliatelle nido mm 5.5



2175
Capelli D' Angelo mm 1



DE MARI

*Extrusion Dies & Equipment for the
Food Industry*



2179
Pennoni sinusoidali mm 29 righi 14



2177
Matassa mm 5

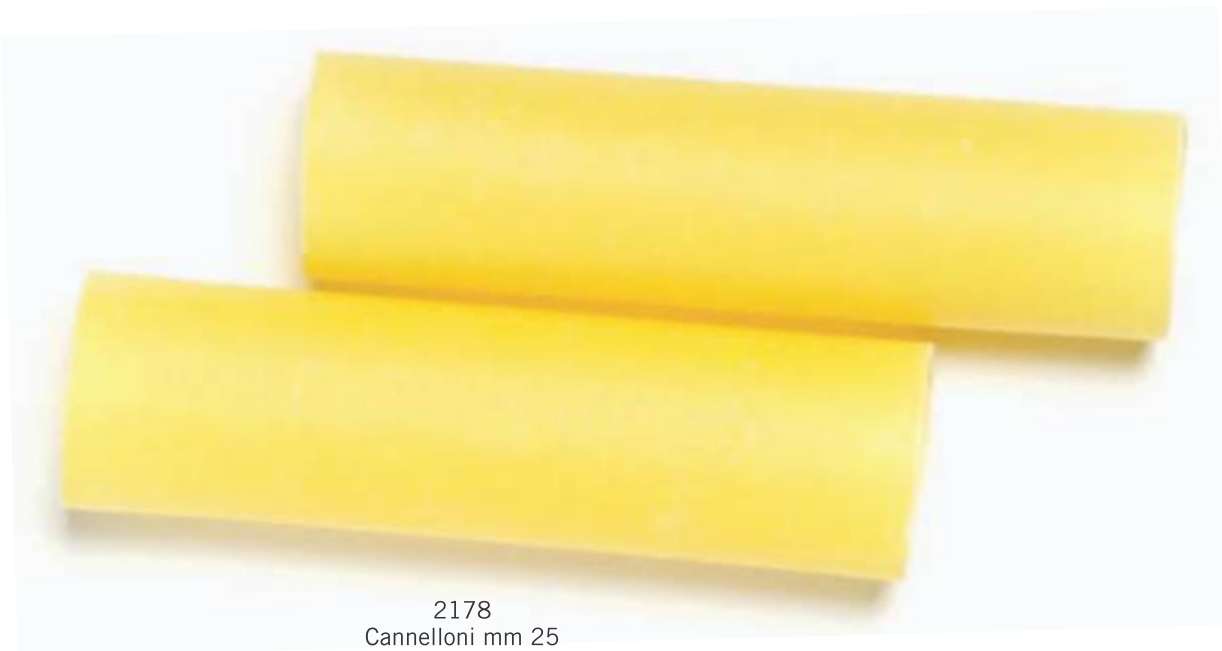

2178
Cannelloni mm 25



DE MARI

Extrusion Dies & Equipment for the
Food Industry

Quick Cooking



3008
Conchiglie mm 22 righi 13



3002
Eliche m 6.5



3012
Conchiglie mm 17, righi 12



3013
Tubetti



3004
Tagliatelle avvolte mm 8

Brass Shapes



4003
Gnocchi sardi mm 17.5



4015
Gemelli mm 6



4010
Riatori mm 12

Brass Shapes



DE MARI

Extrusion Dies & Equipment for the
Food Industry



4016
Casarecce mm 7.5



4017
Casarecce mm 8



4018
Casarecce mm 8.5



4023
Tufoli mm 21 righi 36



4021
Fusilli forati mm 3x1.1



4026
Penne mm 9.5 righi 18



4021
Fusilli forati mm 3x1.1



4032
Tubetti mm 4.6



4033
Tubetti mm 3.8



DE MARI

Extrusion Dies & Equipment for the
Food Industry

Brass Shapes



4044
Tuffoli



4045
Tubetti mm 16, righi 24



4046
Conchiglie mm 18, righi 12



4051
Conchiglie mm 17.5, righi 12



4048
Orecchiette



4050
Orecchiette



4049
Cavatelli

Figure Shapes



DE MARI

Extrusion Dies & Equipment for the
Food Industry



5017



5004



6010



6009



6011



5018



DE MARI

Extrusion Dies & Equipment for the
Food Industry

Figure Shapes



6013



6012



6014



6017



6015



6018



6016



DE MARI

*Extrusion Dies & Equipment for the
Food Industry*

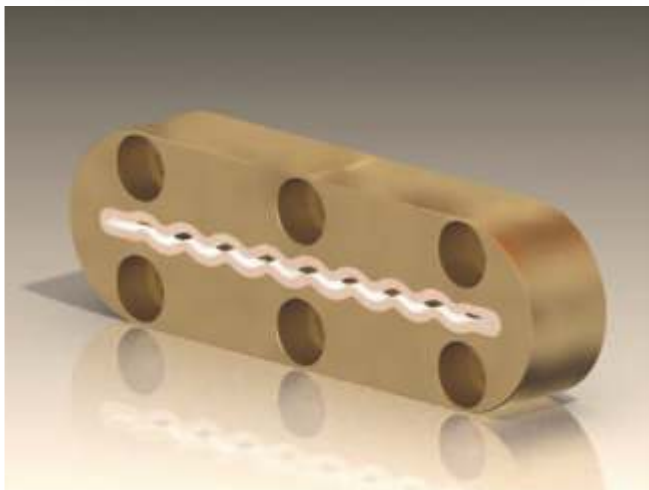
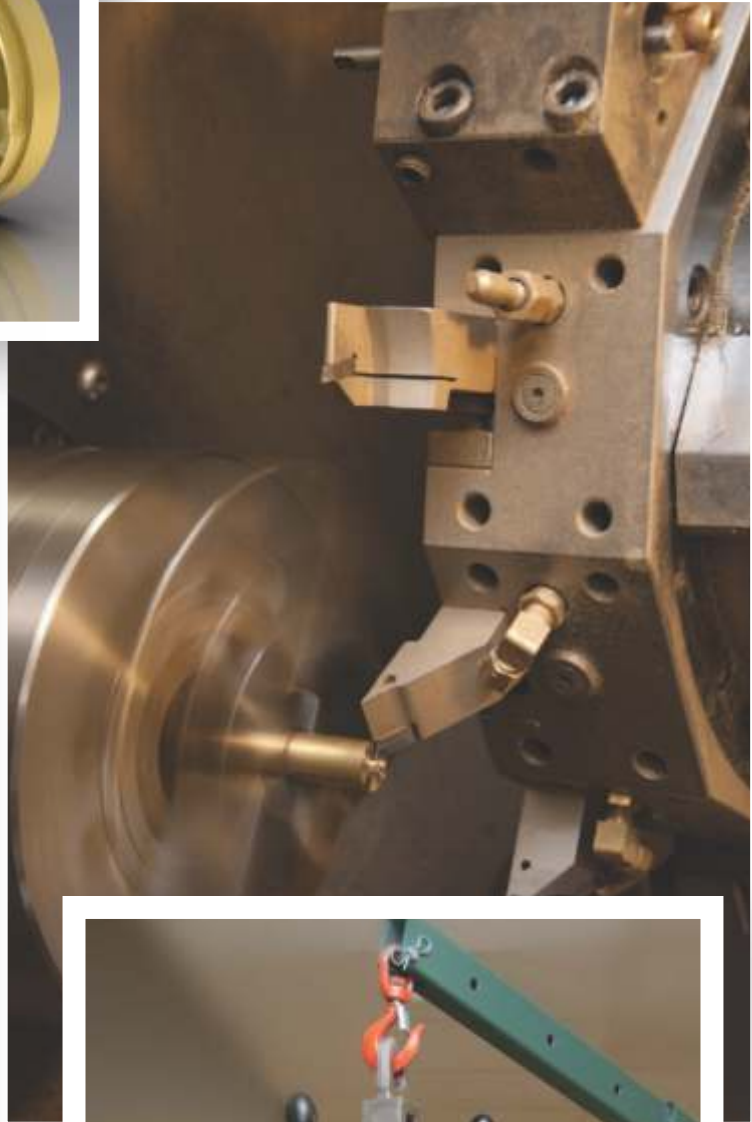
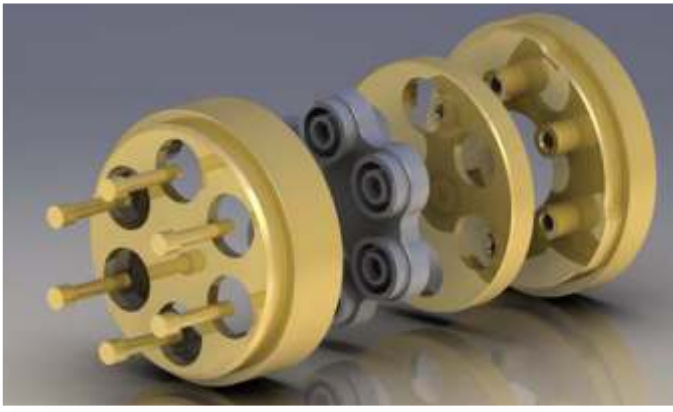



DE MARI

Extrusion Dies & Equipment for the
Food Industry

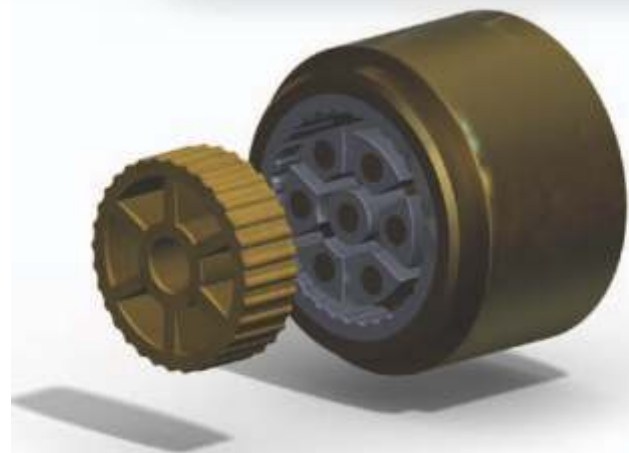
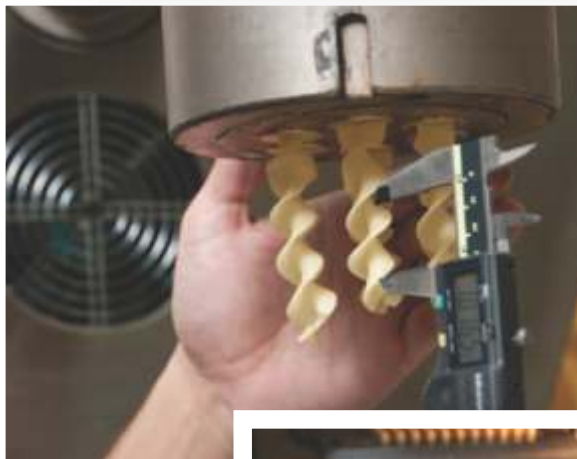
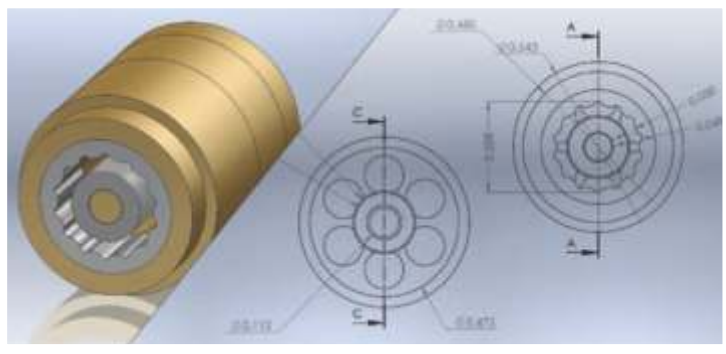



DE MARI

*Extrusion Dies & Equipment for the
Food Industry*





DE MARI

*Extrusion Dies & Equipment for the
Food Industry*

We Shape the World

48 Chuck Drive

Dracut, MA 01826 USA

Tel. 978.454.4099 • Fax. 978.454.1501

sales@demaripastadies.com www.demaripastadies.com